

**1U and Simple Entry Level Series DVR
Quick Start Guide**

Table of Contents

1	Hardware Installation and Connection.....	5
1.1	Check Unpacked DVR.....	5
1.2	About Front Panel and Real Panel.....	5
1.3	After Remove the Chassis.....	5
1.4	HDD Installation.....	5
1.4.1	Standard 1U Series.....	5
1.4.2	Simple Entry Level Series.....	6
1.5	Front Panel.....	7
1.5.1	Standard 1U Series.....	7
1.5.2	Simple Entry Level Series.....	7
1.6	Rear Panel.....	9
1.6.1	Standard 1U Series.....	9
1.6.2	Simple Entry Level Series.....	10
1.7	Connection Sample.....	10
1.8	Alarm Input and Output Connection.....	12
1.8.1	Alarm Input and Output Details.....	12
1.8.2	Alarm Input Port.....	13
1.8.3	Alarm Output Port.....	14
2	Overview of Navigation and Controls.....	15
2.1	Login, Logout & Main Menu.....	15
2.1.1	Login.....	15
2.1.2	Main Menu.....	15
2.1.3	Logout.....	16
2.1.4	Auto Resume after Power Failure.....	16
2.2	Recording Operation.....	16
2.2.1	Live Viewing.....	16
2.3	Record Setup (Schedule).....	16
2.3.1	Schedule Menu.....	16
2.3.2	Manual Record.....	17
2.3.3	Encode.....	18
2.3.4	Snapshot.....	19

2.3.5	Image FTP	19
2.3.6	Search and Playback	20
2.3.7	Basic Operation	21
2.4	Network Setup	22
2.5	Pan/Tilt/Zoom	23
2.5.1	PTZ Setup	23
2.5.2	PTZ Operation	24
2.5.3	3D Intelligent Positioning Key	24
3	Web Client Operation	26
3.1	Network Connection	26
3.2	Login	26
3.3	Main Window	26

Welcome

Thank you for purchasing our DVR!

This quick start guide will help you become familiar with our DVR in a very short time.

Here you can find hardware installation, cable connection information and general operations such as system setup, record, search, backup, alarm setup, PTZ operation, also here you can find web operation instruction.

Before installation and operation, please read the following safeguard and warning carefully!

Important Safeguard and Warning

1 . Electrical safety

All installation and operation here should conform to your local electrical safety codes.

We assume no liability or responsibility for all the fires or electrical shock caused by improper handling or installation.

2 . Transportation security

Heavy stress, violent vibration or water splash are not allowed during transportation, storage and installation.

3 . Installation

Keep upwards. Handle with care.

Do not apply power to the DVR before completing installation.

Do not place objects on the DVR

4 . Qualified engineers needed

All the examination and repair work should be done by the qualified service engineers.

We are not liable for any problems caused by unauthorized modifications or attempted repair.

5 . Environment

The DVR should be installed in a cool, dry place away from direct sunlight, inflammable, explosive substances and etc.

6. Accessories

Be sure to use all the accessories recommended by manufacturer.

Before installation, please open the package and check all the components are included:

Contact your local retailer ASAP if something is missing in your package.

1 Hardware Installation and Connection

Note: All the installation and operations here should conform to your local electric safety rules.

1.1 Check Unpacked DVR

When you receive the DVR from the forwarding agent, please check whether there is any visible damage. The protective materials used for the package of the DVR can protect most accidental clashes during transportation. Then you can open the box to check the accessories.

Please check the items in accordance with the list on the warranty card (Remote control is optional). Finally you can remove the protective film of the DVR.

Note

Remote control is not a standard accessory and it is not included in the accessory bag.

1.2 About Front Panel and Rear Panel

For detail information of the function keys in the front panel and the ports in the rear panel, please refer to the *User's Manual* included in the resource CD.

The model in the front panel is very important; please check according to your purchase order.

The label in the rear panel is very important too. Usually we need you to represent the serial number when we provide the service after sales.

1.3 After Remove the Chassis

Please check the data cable, power cable, COM cable and main board cable connection is firm or not.

1.4 HDD Installation

1.4.1 Standard 1U Series

This series DVR has only one SATA HDD. Please use HDD of 7200rpm or higher.

You can refer to the *User's Manual* for recommended HDD brand.

Please follow the instructions below to install hard disk.



1. Loosen the screws of the upper cover.

2. Remove upper cover.

3. Turn four screws for three rounds to fix HDD bracket.



4. Place the HDD in accordance with the four holes.



5. Turn the device upside down and then turn the screw in firmly.



6. Fix the HDD firmly.



7. Connect the HDD cable and power cable.



8. Place the upper cover back and screw firmly.

After completing HDD installation, please check connection of data ribbon and power cord.

1.4.2 Simple Entry Level Series

This series DVR has only one SATA HDD. Please use HDD of 7200rpm or higher.

You can refer to the *User's Manual* for recommended HDD brand.

Please follow the instructions below to install hard disk.



1. Loosen the screws of rear panel.



2. Loosen the screws of side panel.



3. Lift the front cover up and then remove.



4. Fix four screws in the HDD (Just turn 3 rounds).



5. Place the HDD in accordance with the big four holes in the chassis.



6. Turn the device upside down and then push the four screws to the small holes. Fix the screws firmly.



7. Connect the HDD data cable and power cable.	8. Please fix the clip first and then put the upper cover back.	9. Fix the screws in the front over and the side cover.
--	---	---

Note:

- You can connect the HDD data cable and the power cable first and then fix the HDD in the device.
- Please pay attention to the front cover. It adopts the vertical sliding design. You need to push the clip first and then put down.

1.5 Front Panel

1.5.1 Standard 1U Series

The standard 1U series front panel is shown as in Figure 1-1.

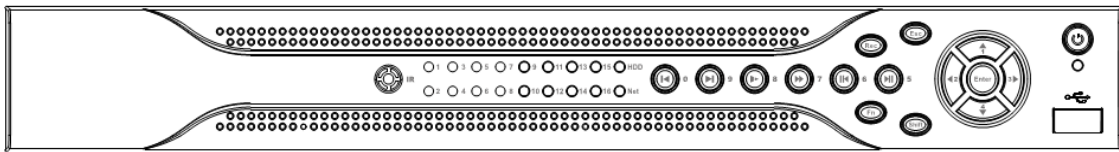

Figure 1-1

1.5.2 Simple Entry Level Series

The simple entry level series front panel is shown as below. See Figure 1-2.

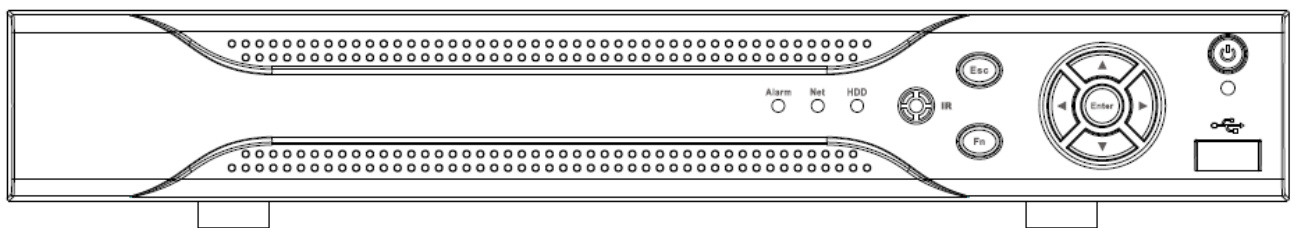



Figure 1-2

Please refer to the following sheet for front panel button information.

Name	Icon	Function
Power button		Power button, press this button for three seconds to boot up or shut down DVR.
Shift	Shift	In textbox, click this button to switch between numeral, English(Small/Capitalized),donation and etc.

Up/1 Down/4	▲、▼	Activate current control, modify setup, and then move up and down.
		Increase/decrease numeral.
		Assistant function such as PTZ menu.
		In text mode, input number 1/4 (English character G/H/I)
Left/2 Right/3	◀ ▶	Shift current activated control,
		When playback, click these buttons to control playback bar. In text mode, input number 2(English character A/B/C) /3(English character D/E/F)
ESC	ESC	Go to previous menu, or cancel current operation.
		When playback, click it to restore real-time monitor mode.
Enter	ENTER	Confirm current operation
		Go to default button
		Go to menu
Record	REC	Manually stop/start recording, working with direction keys or numeral keys to select the recording channel.
Slow play/8	▶	Multiple slow play speeds or normal playback. In text mode, input number 8 (English character T/U/V).
Assistant	Fn	One-window monitor mode, click this button to display assistant function: PTZ control and image color.
		Backspace function: in numeral control or text control, press it for 1.5seconds to delete the previous character before the cursor.
		In motion detection setup, working with Fn and direction keys to realize setup.
		In text mode, click it to switch between numeral, English character(small/capitalized) and etc.
		Realize other special functions.
Fast play/7	▶▶	Various fast speeds and normal playback. In text mode, input number 7 (English character P/Q/R/S).
Play previous/0	⏮	In playback mode, playback the previous video In text mode, input number 0.
Reverse/Pause/6	⏪	In normal playback or pause mode, click this button to reverse playback In reverse playback, click this button to pause playback. In text mode, input number 6 (English character M/N/O)
Play Next/9	⏭	In playback mode, playback the next video In menu setup, go to down ward of the dropdown list. In text mode, input number 9 (English character W/X/Y/Z)

Play/Pause /5	▶	In normal playback click this button to pause playback In pause mode, click this button to resume playback. In text mode, input number 5(English character J/K/L).
USB port		To connect USB storage device, USB mouse.
Network abnormal indication light	Net	Network error occurs or there is no network connection, the light becomes red to alert you.
HDD abnormal indication light	HDD	HDD error occurs or HDD capacity is below specified threshold value, the light becomes red to alert you.
Record light	1-16	System is recording or not. It becomes on when system is recording.
IR Receiver	IR	It is to receive the signal from the remote control.
Alarm indication light	Alarm	There is external alarm or not. The light becomes on if there is an external alarm. The light becomes off once the alarm stops.

1.6 Rear Panel

1.6.1 Standard 1U Series

The 4-ch rear panel is shown as below. See Figure 1-3.

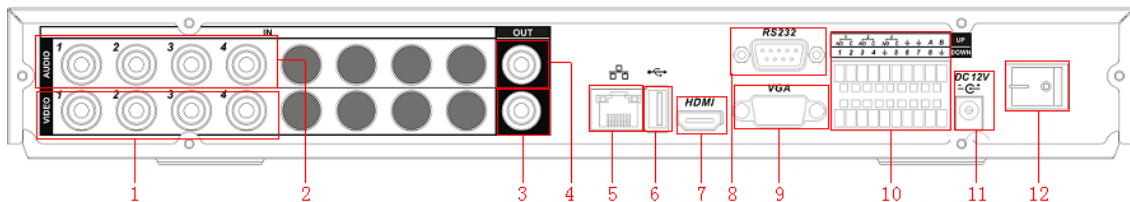

Figure 1-3

The 8-ch rear panel is shown as below. See Figure 1-4.

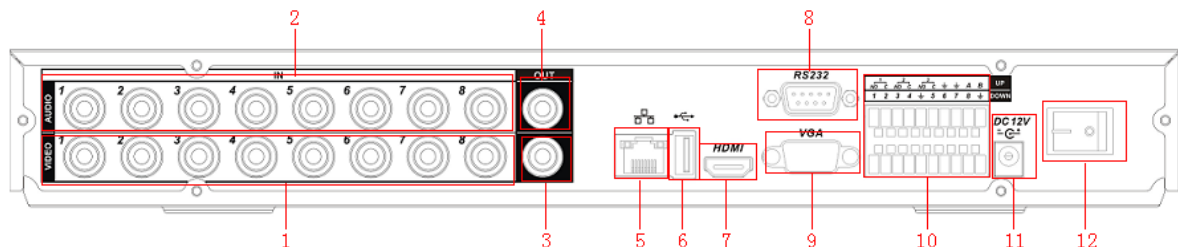

Figure 1-4

The 16-ch rear panel is shown as below. See Figure 1-5.

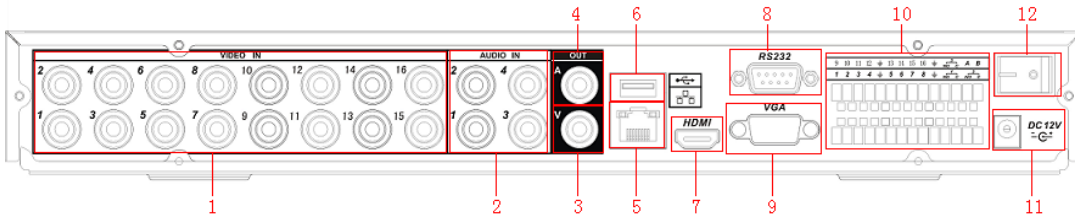

Figure 1-5

Please refer to the following sheet for detail information.

1	Video input
2	Audio input
3	Video CVBS output
4	Audio output
5	Network port
6	USB port
7	HDMI port
8	RS232 port
9	Video VGA output
10	Alarm input/alarm output/RS485 port
11	Power input port
12	Power button

1.6.2 Simple Entry Level Series

The simple entry level series rear panel is shown as below. See Figure 1-6.

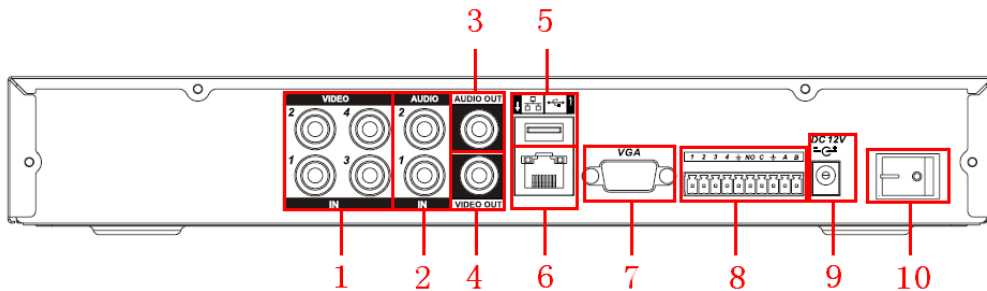

Figure 1-6

Please refer to the following sheet for detail information.

1	Video input
2	Audio input
3	Audio output
4	Video CVBS output
5	USB port
6	Network port
7	Video VGA output
8	Alarm input/alarm output/RS485 port
9	Power input port
10	Power button

When connect the Ethernet port, please use straight cable to connect the PC and use the crossover cable to connect to the switcher or router.

1.7 Connection Sample

Please refer to Figure 1-7 for 1U 8-ch series connection sample.

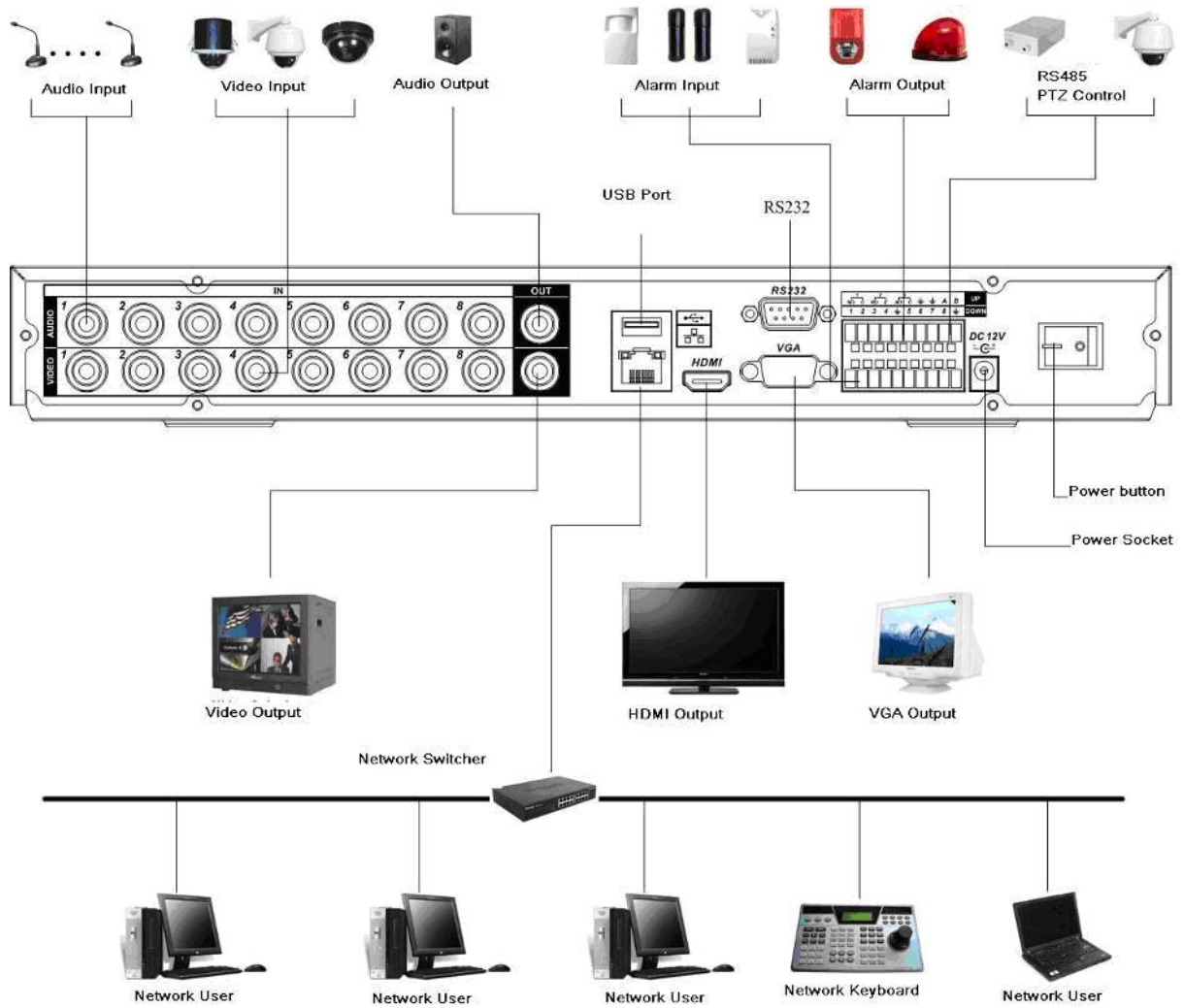

Figure 1-7

Please refer to Figure 1-8 for simple entry level series connection sample.

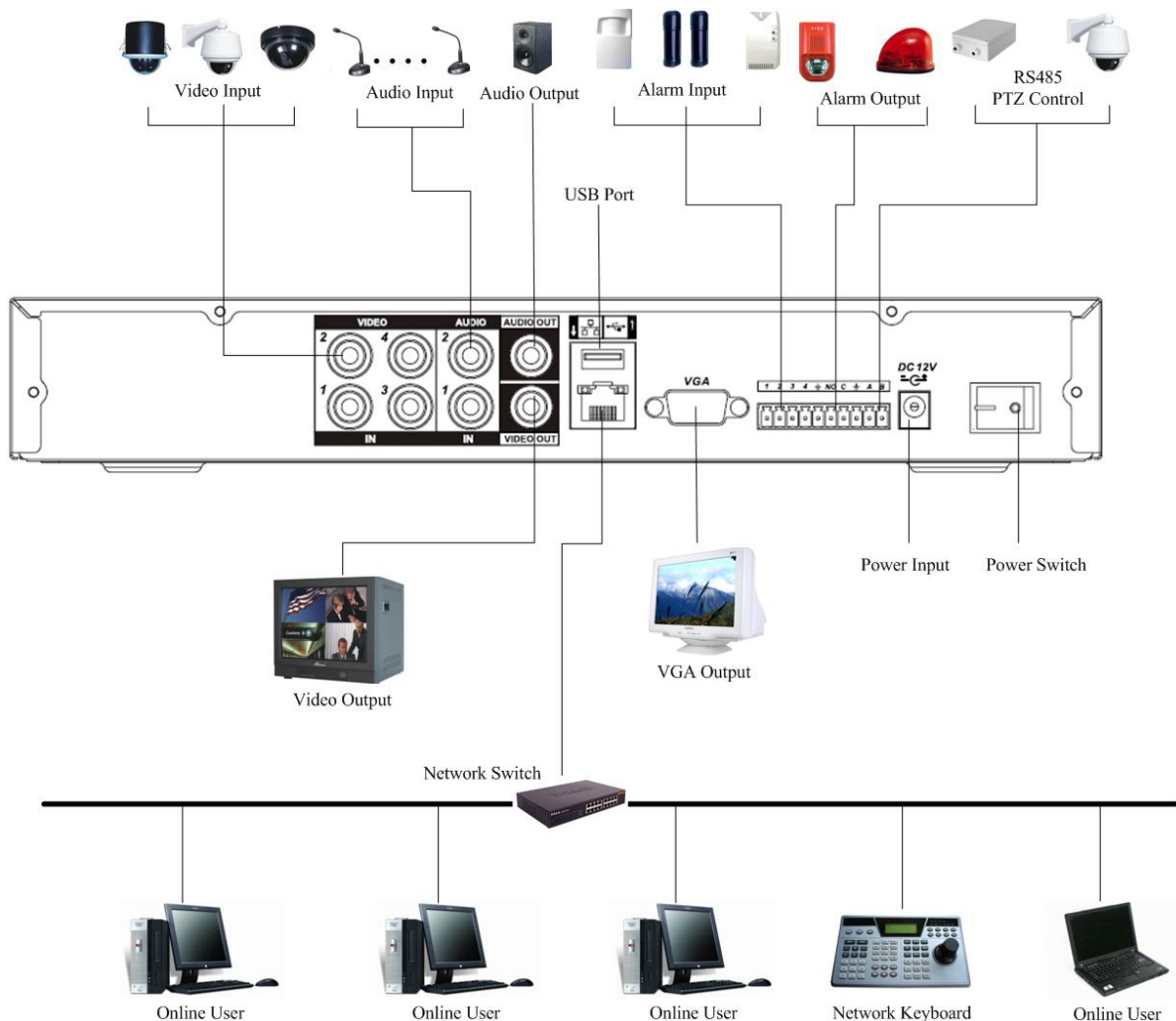

Figure 1-8

1.8 Alarm Input and Output Connection

There are two alarm input types for you to select: normal open (NO) and normal close (NC).

1.8.1 Alarm Input and Output Details

Standard 1U series

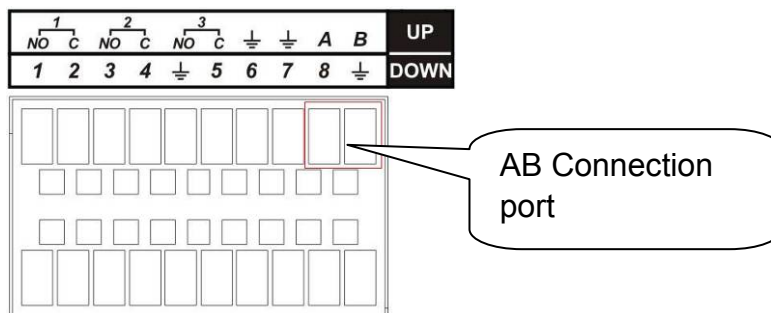



Figure 1-9 Standard 1U Series

You can refer to the following sheet and Figure 1-9 for alarm input and output information.

Parameter	Grounding Alarm
	Ground line
Alarm Input	1, 2, ..., 8. It becomes valid in low voltage.
1-NO C, 2-NO C, 3-NO C	Three NO activation outputs.
Relay Output	1,2,3,4: NO and C(Normally Open and Com) 5: NO,C and NC(Normally Open, Com, Normally Closed) 6: Ctrl 12V(This is used for reset the sensor)
485 A/B	485 communication port. They are used to control devices such as PTZ. Please parallel connect 120Ω between A/B cables if there are too many PTZ decoders.

Simple Entry Level Series

You can refer to the following sheet and Figure 1-10 for alarm input and output information.

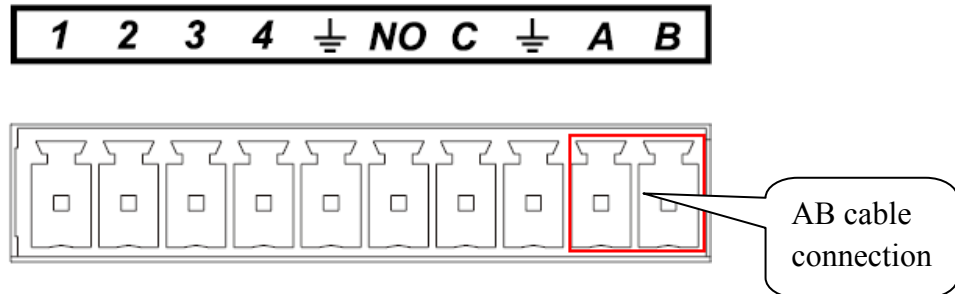



Figure 1-10 Simple Entry Level Series

Parameter	
	Ground line
1/2/3/4	ALARM1~ALARM4. It becomes valid in low voltage.
NO	One normal output (NO) activation output(on-off).
485 A/B	485 communication port. They are used to control devices such as PTZ. Please parallel connect 120Ω between A/B cables if there are too many PTZ decoders.

1.8.2 Alarm Input Port

Please refer to the following sheet for more information.

- 4/8/16-ch grounding alarm inputs. (Normal open or Normal close type)
- Please parallel connect COM end and GND end of the alarm detector (Provide external power to the alarm detector).
- Please parallel connect the Ground of the DVR and the ground of the alarm detector.
- Please connect the NC port of the alarm sensor to the DVR alarm input(ALARM)
- Use the same ground with that of DVR if you use external power to the alarm device.

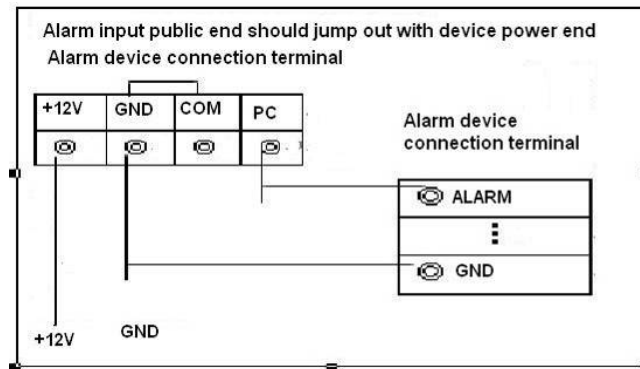

Figure 1-11

1.8.3 Alarm Output Port

- The standard 1U series has 3-way relay alarm output (NO contact) and the simple entry level series has one relay alarm output. Provide external power to external alarm device.
- To avoid overloading, please read relay parameters sheet in the *User's Manual* carefully.
- RS485 A/B cable is for the A/B cable of the PTZ decoder.

2 Overview of Navigation and Controls

Before operation, please make sure you have properly installed HDDs and all the cable connections.

2.1 Login, Logout & Main Menu

2.1.1 Login

After system booted up, default video display is in multiple-window mode.

Click Enter or left click mouse, you can see the login interface. See Figure 2-1.

System consists of four accounts:

- **Username:** admin. **Password:** admin. (administrator, local and network)
- **Username:** 888888. **Password:** 888888. (administrator, local only)
- **Username:** 666666. **Passwords:** 666666(Lower authority user who can only monitor, playback, backup and etc.)
- **Username:** default. **Password:** default(hidden user)

You can use USB mouse, front panel, remote control (not included in the accessory bag) or

keyboard to input. About input method: Click  to switch between numeral, English character (small/capitalized) and denotation.

Note:

For security reason, please modify password after you first login.

Within 30 minutes, three times login failure will result in system alarm and five times login failure will result in account lock!



Figure 2-1

2.1.2 Main Menu

After you logged in, the system main menu is shown as below. See Figure 2-2.

There are total six icons: search, information, setting, backup, advanced and shutdown.

You can move the cursor to highlight the icon, and then double click mouse to enter the sub-menu.

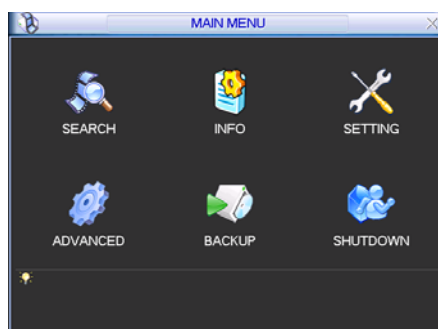

Figure 2-2

2.1.3 Logout

There are two ways for you to log out.

The first one is from menu option:

In the main menu, click shutdown button, you can see an interface is shown as below. See Figure 2-3.

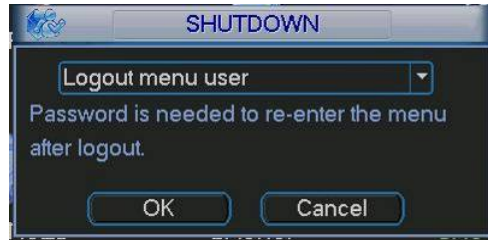

Figure 2-3

There are several options for you. See Figure 2-4.

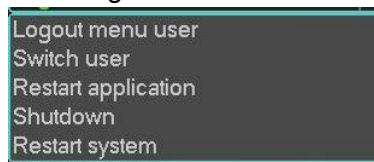

Figure 2-4

The other ways is to press power button on the front panel for at least 3 seconds, system will stop all operations. Then you can click the power button in the front panel to turn off the DVR. Please note, before you replace the HDD, do remember shutting down the device and unplug the power cable.

2.1.4 Auto Resume after Power Failure

The system can automatically backup video and resume previous working status after power failure.

2.2 Recording Operation

2.2.1 Live Viewing

After you logged in, the system is in live viewing mode by default. You can see system date, time and channel name. If you want to change system date and time, you can refer to general settings (Main Menu->Setting->General). If you want to modify the channel name, please refer to the display settings (Main Menu->Setting->Display)

1		Recording status	3		Video loss
2		Motion detection	4		Camera lock

2.3 Record Setup (Schedule)

Note:

You need to have proper rights to implement the following operations. Please make sure the HDDs have been properly installed.

After the system booted up, it is in default 24-hour regular mode. You can set record type and time in schedule interface.

2.3.1 Schedule Menu

In the main menu, from Setting to Schedule, you can go to schedule menu. See Figure 2-5. There are total six periods.

- Channel: Please select the channel number first. You can select “all” if you want to set for the whole channels.
- Week day: There are eight options: ranges from Saturday to Sunday and all.
- Pre-record: System can pre-record the video before the event occurs into the file. The value ranges from 1 to 30 seconds depending on the bit stream.
- Redundancy: System supports redundancy backup function. You can highlight Redundancy button to activate this function. Please note, before enable this function, please set at least one HDD as redundant. (Main menu->Advanced->HDD Management). Please note redundancy function **does not** applies to 1U series since there is only one HDD,
- Snapshot: You can enable this function to snapshot image when alarm occurs.
- Record types: There are three types: regular, motion detection (MD) and Alarm.

Please highlight icon  to select the corresponding function. After completing all the setups please click save button, system goes back to the previous menu.

At the bottom of the menu, there are color bars for your reference. Green color stands for regular recording, yellow color stands for motion detection and red color stands for alarm recording.

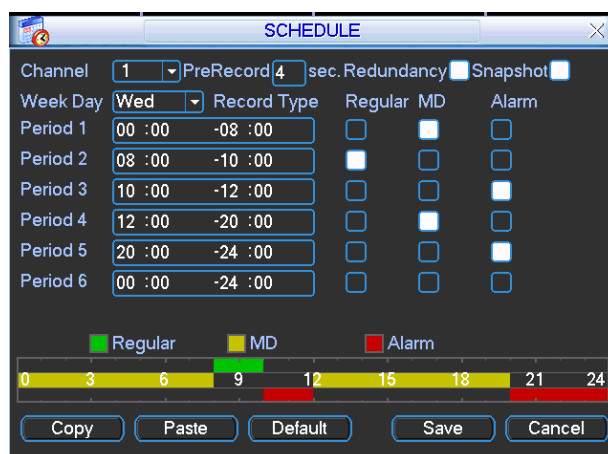

Figure 2-5

2.3.2 Manual Record

Note:

Please make sure you have the record operation right and you have properly installed the formatted HDD.

You can right click mouse or in the main menu, from Advanced->Manual Record to go to record interface.

There are three statuses: schedule/manual/stop. Highlight icon “○” to select corresponding channel. See Figure 2-6.

- Manual: The highest priority. After manual setup, all selected channels will begin ordinary recording.
- Schedule: Channel records as you have set in recording setup (Main Menu->Setting->Schedule)
- Stop: All channels stop recording.



Figure 2-6

2.3.3 Encode

Encode interface is shown as in Figure 2-7.

- Channel: Select the channel you want.
- Compression: System supports H.264.
- Resolution: System supports various resolutions, you can select from the dropdown list. For this model, main stream supports D1/CIF/QCIF. Please note the resolution may vary due to different channels. The extra stream supports QCIF only.
- Frame rate: It ranges from 1f/s to 25f/s in NTSC mode and 1f/s to 30f/s in PAL mode.

Note:

For the 8-ch series DVR, you can refer to the following information:

If the 1-channel resolution is D1 and the frame rate is more than 6f/s, then the rest seven channels (the second channel to the eighth channel) resolution shall be CIF or QCIF.

If the 1-channel resolution is D1 and the frame rate is or less than 6f/s, then the rest seven channels (the second channel to the eighth channel) resolution shall be D1/CIF/QCIF. Right now in D1 resolution, the max frame rate is 6f/s.

- Bit rate type: system supports two types: CBR and VBR. In VBR mode, you can set video quality.
- Quality: There are six levels ranging from 1 to 6. The sixth level has the highest image quality.
- Video/audio: you can enable or disable the video/audio. Please note the video is enabled for main stream by default. For extra stream, please enable video first and then enable audio.
- Snapshot: Click snapshot button, you can see it contains the four items: mode/image size/image quality/snapshot frequency. Please refer to chapter 2.3.3 for detail information.

Please highlight icon  to select the corresponding function.

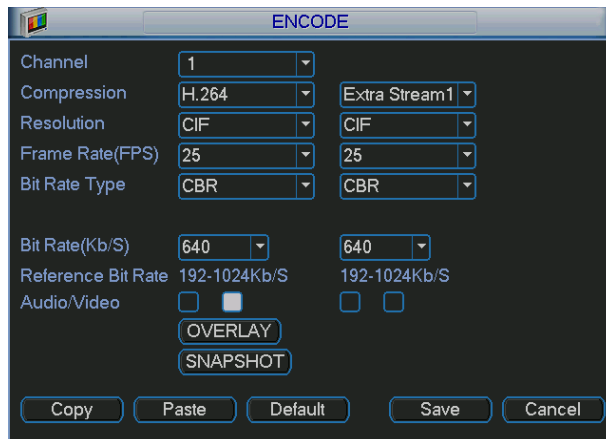

Figure 2-7

2.3.4 Snapshot

2.3.4.1 Schedule Snapshot

In Encode interface, click snapshot button to input snapshot mode, size, quality and frequency.

In General interface please input upload interval.

In Schedule interface, please enable snapshot function.

Please refer to the following figure for detail information. See Figure 2-8.



Figure 2-8

2.3.4.2 Activation Snapshot

Please follow the steps listed below to enable the activation snapshot function. After you enabled this function, system can snapshot when the corresponding alarm occurred.

- In Encode interface, click snapshot button to input snapshot mode, size, quality and frequency.
- In General interface please input upload interval.
- In Detect interface please enable snapshot function for specified channels. Or in Alarm interface please enable snapshot function for specified channels.

Please refer to the following figure for detail information. See Figure 2-9.

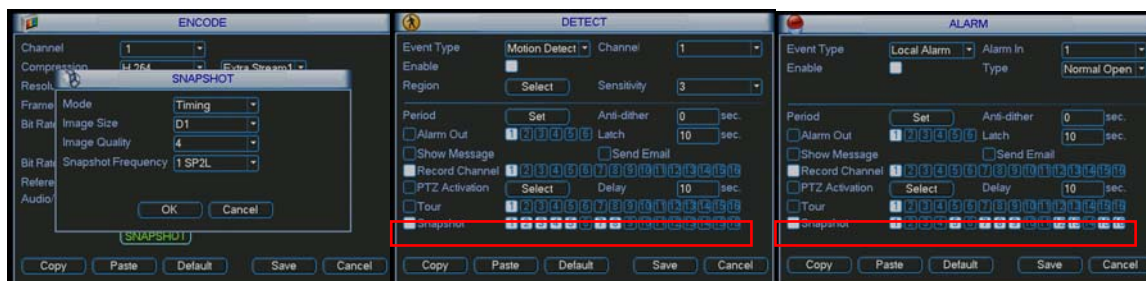

Figure 2-9

2.3.4.3 Priority

Please note the activation snapshot has the higher priority than schedule snapshot. If you have enabled these two types at the same time, system can activate the activation snapshot when alarm occurs, and otherwise system just operates the schedule snapshot.

2.3.5 Image FTP

In Network interface, you can set FTP server information. Please enable FTP function and then click save button. See Figure 2-10. Please refer to the *User's Manual* included in the resource CD for detailed information.

Please boot up corresponding FTP server.

Please enable schedule snapshot or activation snapshot (Chapter 2.3.3) and then system can upload the image file to the FTP server.

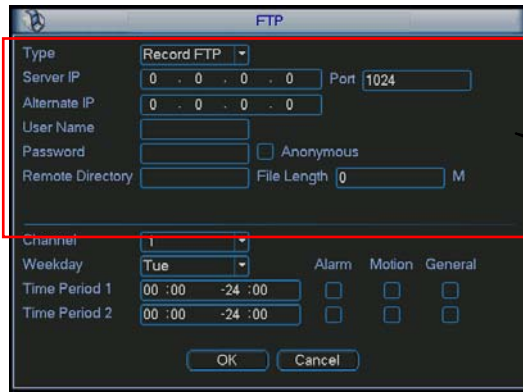

Please input the corresponding information here, if you just upload the image FTP.

Figure 2-10

2.3.6 Search and Playback

Click search button in the main menu, search interface is shown as below. See Figure 2-11.

Usually there are three file types:

- R: Regular recording file.-
- A: External alarm recording file.
- M: Motion detection recording file

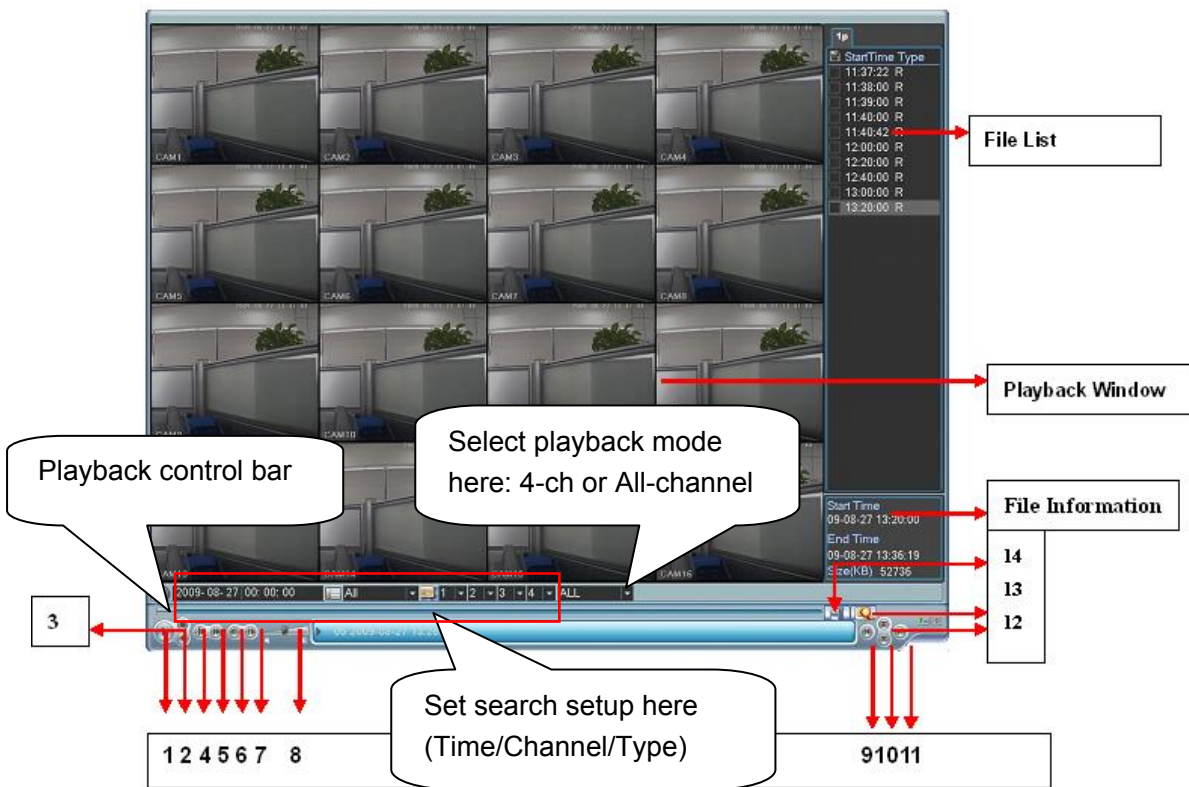

Figure 2-11

Please refer to the following sheet for more information.

Serial Number	Function
1	Play
2	Backward
3	Stop

4	Slow play
5	Fast play
6	Previous frame
7	Next frame
8	Volume
9	Previous file
10	Next channel
11	Next file
12	Previous channel
13	Search
14	Backup

2.3.7 Basic Operation

2.3.7.1 Playback Operation

There are various search modes: video type, channel number or time. The system can max display 128 files in one screen. You can use page up/down button to view if there are more than one page.

Select the file name and double click mouse (or click enter button), you can view file content.

2.3.7.2 Playback Mode

There are two playback modes: 4-ch and all-channel. In 4-ch playback mode, you can select the 1/2/3/4-ch playback according to your requirement. In all-channel mode, system can playback in full channels. Please note the 4-ch has no all-channel playback mode.

2.3.7.3 Accurate playback

Input time (h/m/s) in the time column and then click playback button, system can operate accurate playback.

2.3.7.4 Synchronized playback function when playback

During playback process, click numeral key, system can switch to the corresponding channel video of the same time.

2.3.7.5 Digital zoom

When the system is in full-screen playback mode, drag your mouse in the screen to select a section and then left click mouse to realize digital zoom. You can right click mouse to exit.

2.3.7.6 File backup

System supports backup operation during search. You can draw a √ before file name (multiple choices). Then click backup button (Button 14 in Figure 2-11).

2.3.7.7 Calendar

Click calendar icon  in Figure 2-11, system pops up a calendar for your reference.

The highlighted date means there are record files in that day. You can click blue date to view file list.

In the following interface you can see there are video files in March 13th and 14th. Double click the date to view file list.

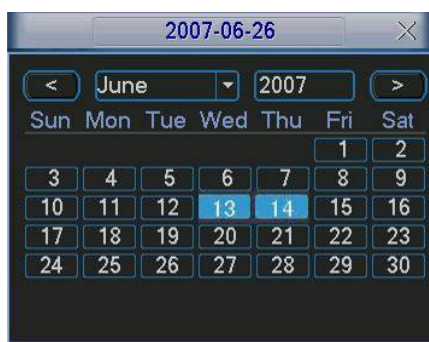

Figure 2-12

2.3.7.8 Slow playback and fast playback

Please refer to the following sheet for slow play and fast playback function.

Button	Illustration	Remarks
Fast play button ►►	In playback mode, click this button to switch between various fast play modes such as fast play 1, fast play 2 and more.	Frame rate may vary due to different versions.
Slow play button ►	In playback mode, click this button to switch between various slow play modes such as slow play 1 or slow play 2.	
Play/Pause ►►	In slow playback mode, click this button to switch between play/pause modes.	
Previous/next	In playback mode, you can click ◀ and ▶ to view previous or next video in current channel.	

2.3.7.9 Backward playback and frame by frame playback

Button	Illustration	Remarks
Backward play: ◀ in playback interface.	In normal playback mode, left click backward play button◀, system begins backward playback. Double click backward play button again, system goes to pause mode.	When system is in backward play or frame by frame playback mode, you can click play button►/ to go to normal playback.
Manual playback frame by frame.	Click pause button in normal playback mode, you can use ◀ and ▶ to view frame by frame.	

Note:

All the operations here (such as playback speed, channel, time and progress) have relationship with hardware version. Some series DVRs do not support some functions or playback speeds.

2.4 Network Setup

Here is for you to input network information. See Figure 2-13.

- IP address: Here you can input IP address.
- DHCP: It is auto search IP function. When enable DHCP function, you can not modify IP/Subnet mask /Gateway. These values are from DHCP function. If you have not enabled DHCP function, IP/Subnet mask/Gateway display as 0. You need to disable DHCP function to view current IP information. Besides, when PPPoE is operating, you can not modify IP/Subnet mask /Gateway.

- TCP port: Default value is 37777.
- UDP port: Default value is 37778.
- HTTP port: Default value is 80.
- Max connection: system support maximal 10 users. 0 means there is no connection limit.
- Transfer mode: Here you can select the priority between fluency/video qualities.
- Network download: System can process the downloaded data first if you enable this function.
- Advanced setting: Please refer to the *user's manual* included in the resource CD for detail information.

After completing all the setups please click save button, system goes back to the previous menu.

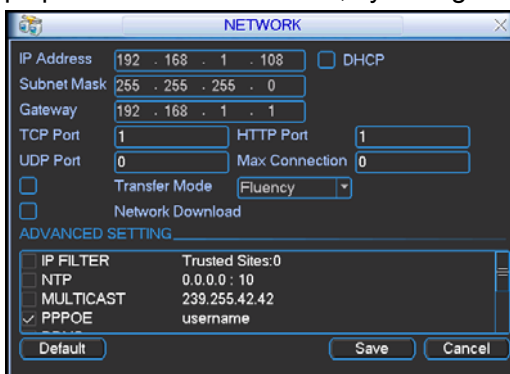

Figure 2-13

2.5 Pan/Tilt/Zoom

Please note:

- Slight difference may be found in the user's interface, due to various protocols.
- Please make sure the speed domes A/B cables are properly connected to the A/B ports of DVR.
- You have properly set PTZ information.
- Please switch camera monitor channel to current window.

2.5.1 PTZ Setup

The pan/tilt/zoom setup includes the following items. Please select channel first. See Figure 2-14.

- Protocol: Select corresponding PTZ protocol such as PELCOD.
- Address: Input corresponding PTZ address.
- Baud rate: Select baud rate.
- Data bit: Select data bit. Default value is 8.
- Stop bit: Select stop bit. Default value is 1.
- Parity: There are three choices: none/odd/even. Default value is none.



Figure 2-14

After completing all the setups please click save button, system goes back to the previous menu.

2.5.2 PTZ Operation

In one window display mode, right click mouse (click “Fn” Button in the front panel or click “Fn” key in the remote control). The interface is shown as in Figure 2-15.

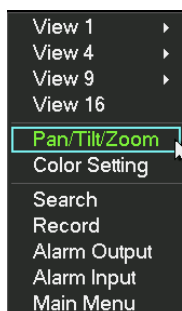

Figure 2-15

Click Pan/Tilt/Zoom, the interface is shown as below. See Figure 2-16.

Here you can set the following items:

- Step: value ranges from 1 to 8.
- Zoom
- Focus
- Iris

Click icon  and  to adjust zoom, focus and iris.



Figure 2-16

In Figure 2-16, please click direction arrows (See Figure 2-17) to adjust PTZ position. There are total 8 direction arrows. Please note if you use remote control, you can use just four directions (Up/down/left/right).

The speed value ranges from 1 to 8.

Figure 2-17



2.5.3 3D Intelligent Positioning













Key

In the middle of the eight direction arrows, there is a 3D intelligent positioning key. See Figure 2-18. Please note, this function needs protocol supported and can only be operated by mouse. Click this key, system goes back to the single screen mode. Drag the mouse in the screen to adjust section size. It can realize PTZ automatically.



Figure 2-18

Here is a sheet for you reference.

Name	Function key	function	Shortcut key	Function key	function	Shortcut Key
Zoom		Near			Far	
Focus		Near			Far	
Iris		close			Open	

You can click set button in Figure 2-16 (or click REC button in the front panel) to set preset, tour, and pattern.

You can click page switch button in Figure 2-16(or click Fn button in the front panel) to call main function.

3 Web Client Operation

Slightly difference may be found in the interface due to different series.

3.1 Network Connection

Before web client operation, please check the following items:

- Network connection is right
- DVR and PC network setup is right. Please refer to network setup(main menu->setting->network)
- Use order ping `***.***.***.***`(* DVR IP address) to check connection is OK or not. Usually the return TTL value should be less than 255.
- System can automatically download latest web control and the new version can overwrite the previous one.
- If you want to un-install the web controls, please run `uninstall webrec2.0.bat` to auto delete the control or you can go to `C:\Program Files\webrec` to delete Single folder.

3.2 Login

Open IE and input DVR address in the address column. For example, if your DVR IP is 10.10.3.16, then please input `http:// 10.10.3.16` in IE address column.

System pops up warning information to ask you whether install `webrec.cab` control or not. Please click yes button.

If you can't download the ActiveX file, please modify your IE security setup.

After installation, the interface is shown as below. See Figure 3-1.

Please input your user name and password.

Default factory name is admin and password is admin.

Note: For security reasons, please modify your password after you first login.

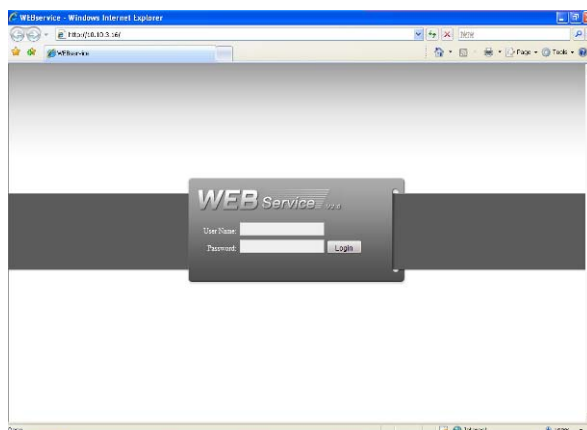

Figure 3-1

3.3 Main Window

After you logged in, you can see the main window. See Figure 3-2.

Click the channel name on the left side; you can view the real-time video.

For detailed operation information, please refer to the *User's Manual* included in the resources CD.



Figure 3-2

Note

- For detailed operation introduction, please refer to our resource CD included in your package for electronic version of the *User's Manual*.
- Slight difference may be found in user interface.
- All the designs and software here are subject to change without prior written notice.
- Please visit our website for more information.